

Single Mode Fiber Coupled Laser Module

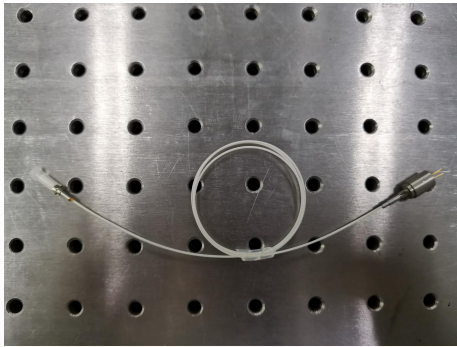

Features

- 496nm Diode Laser
- 3.5um SM Fiber
- Fast Rise Time

Model Number	B496-SMF10
Center Wavelength ⁽¹⁾	496nm
Operating Voltage (DC)	7.5V
Operating Current	70mA
Output Power ⁽¹⁾	10mW
Fiber coupling efficiency	> 30%

Dimensions (Unit: mm)

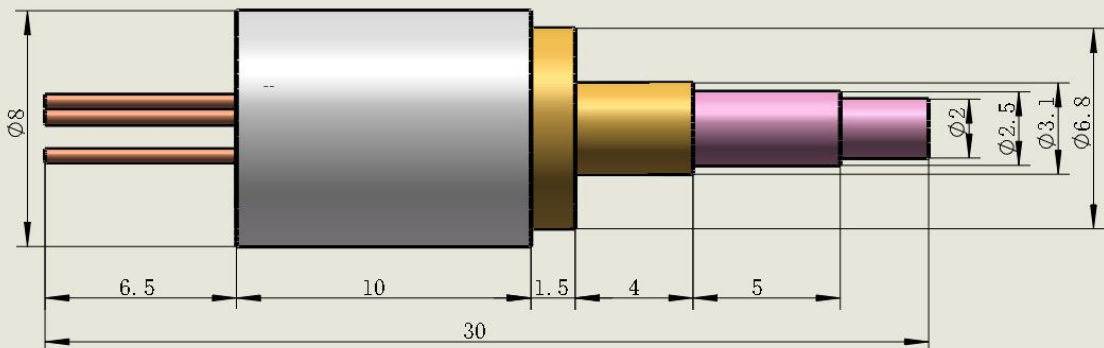

图纸1

⁽¹⁾ after fiber, over Operating Case Temperature Range

Specifications				
Mechanical Specifications		Min	Typ	Max
Laser Head	Diameter (mm)	-	8	-
	Length (mm)	-	30	-
	Weight (g)	-	130	-
Housing Material		SUS304		
Optical Specifications		Min	Typ	Max
Center Wavelength@25°C		-	496	-
Spectral Width(FWHM)		-	1	2
Output Power(mW)@25°C		10	-	-
Power Stability @ 25°C		-	±2%	±5%
M ²		-	2.1	2.5
Longitudinal Mode		Single Mode Fiber		
Output Power Mode		CW		
Laser Class		3B		
Fiber Specifications		Min	Typ	Max
Fiber Type		3.5/125um with 900um loose tube		
Fiber Numerical Aperture			0.12	
Fiber Length (m)			0.5	
Fiber Termination		FC connector		
Fiber Length		-	500	-
Reliability		Min	Typ	Max
Operating Case Temperature Range (°C)		-10	-	60
Storage Temperature (°C)		-40	-	85
Environmental Humidity (RH, %)		5	-	85
Lifetime (hours) (MTTF at 25°C)		2,000	-	-
RoHS Compliance Declaration		Yes		

Beam Picture

